

Industrial Air Filtration Gas Turbine/Air Inlet Filtration



Thenow Health Group



Business DEPT.1

Air Compressor Filter Elements
Filter Kingdom, Green World



Business DEPT.2

Screw Air Compressor Lubricant, Spare
Parts and Service
Special Lubricant, Professional Quality



Business DEPT.3

Refrigerated Air Dryer, Pipeline filter
Ultimate Efficiency and Quality



Business DEPT.4

Indoor Air Quality Control devices
ERV/HRV famous brand in domestic market



Business DEPT.5

HVAC air filters
For Clean Air Tomorrow



Business DEPT.6

Dust Collector filter cartridges
Various flanges and filter media options

Foreign Trade Manager

Karen Wang

Tel: +86-21-59177719(Direct Line)
Fax: +86-21-66613500
Email: info@thenow.cn
karenwang@thenow.cn

R&D

Guodong Zhang

Tel: +86-21-51082108-803
Fax: +86-21-66613500
Email: zhangguodong@thenow.cn

Service

Kate Zhu

Tel: +86-21-51082108-808
Fax: +86-21-66613500
Email: zhuyi@thenow.cn

Dust collector filters

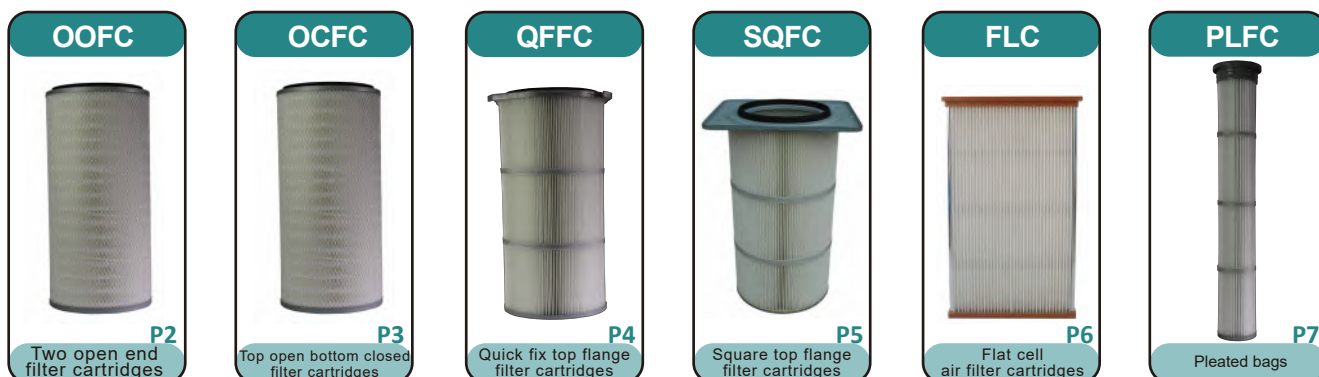

Air Inlet/Gas turbine



Principles of filtration.....	15
Application.....	16
About Thenow.....	17
Production.....	18
Quality control.....	19
R&D.....	20
Service.....	21

Oofc series

2 open end caps filter cartridges

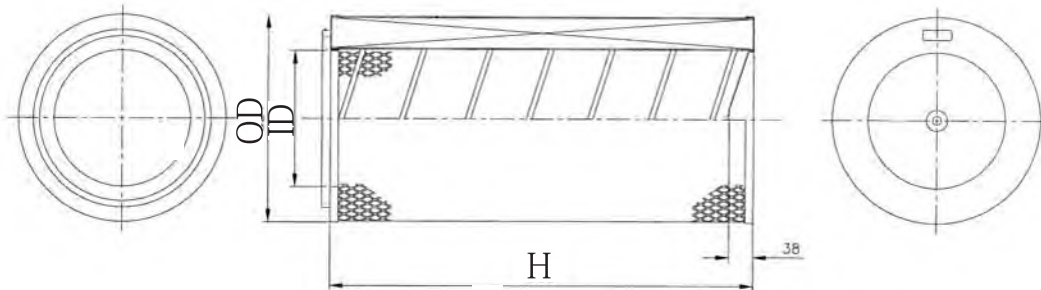

SPECIFICATIONS	
NO.	Description
1	Marking
2	Gasket
3	Inner liner
4	Open bottom end cap
5	Media pack
6	Open top end cap
7	Outer liner/Straps
8	Inner beading

DIMENSIONS			
Model	OD (mm)	H (mm)	ID (mm)
TN10791600	201	406	92
TN11211500	308	381	195
TN11212300	308	597	196
TN11271800	324	457	213
TN11272500	324	641	213
TN11272600	324	660	222
TN11272601	324	660	406
TN11273900	324	991	213
TN11382200	352	559	241
TN11382300	351	584	241
TN11382500	351	641	241
TN11382600	352	660	249
TN11382700	351	686	241
TN11383000	351	762	241
TN11424000	362	1016	251
TN11502800	381	711	254
TN11602200	406	559	291
TN11602300	406	597	245
TN11631600	415	422	305
TN11632400	416	610	303
TN11751800	447	457	311
TN11752100	447	533	311
TN11802700	459	699	313

APPLICATIONS



TOP CAP



INNER MESH

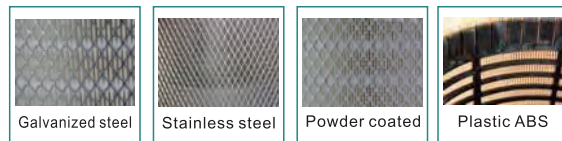

FILTER MEDIA

Cellulose polyester blend
100% cellulose
100% polyester

TREATMENT

Nano
Conductive
Flame Retardant
ePTFE Membrane
PTFE coating
Oil, water proof

BOTTOM CAP



OUTSIDE MESH/STRAPS



OCFC series

Top Open bottom closed filter cartridges

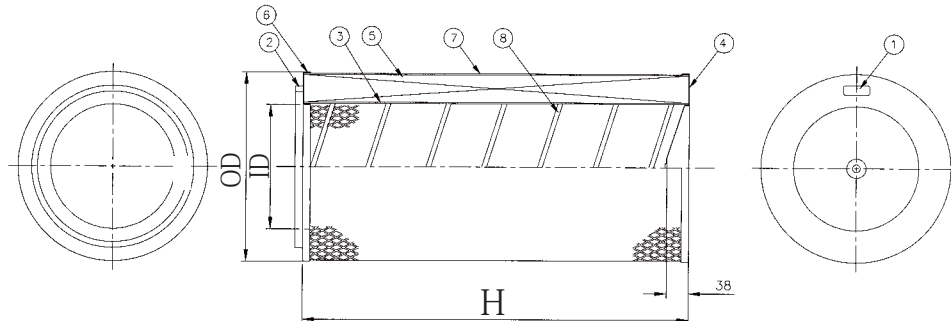

SPECIFICATIONS

NO.	Description
1	Marking
2	Gasket
3	Inner liner
4	Bottom end cap with or without hole
5	Media pack
6	Top end cap
7	Inner beading
8	With or without outer liner

DIMENSIONS

Model	OD (mm)	H (mm)	ID (mm)
TN10792220	201	559	92
TN112118218	308	470	295
TN112120223	308	518	196
TN11272611	324	660	213
TN112729214	324	750	213
TN11273010	324	764	213
TN113826214	352	660	240
TN113828222	352	711	240
TN113836214	352	914	240
TN114028222	356	711	247
TN11403910	356	991	243
TN114624223	373	622	263
TN114630214	373	762	262
TN114724223	374	610	262
TN115024222	383	622	254
TN11601110	406	292	244
TN11601110	406	292	245
TN11601110	406	292	291
TN11601210	406	305	292
TN116028214	406	718	291
TN116034214	406	876	291
TN116030214	408	762	291
TN116034214	408	864	292
TN11662010	422	508	269
TN11752614	445	660	356
TN11752610	447	660	311
TN11762610	447	660	356
TN117624214	448	610	311
TN11872010	476	508	356
TN11872510	476	635	356
TN11921010	489	263	327
TN11921310	489	351	327
TN12202410	559	629	395
TN12222510	565	635	448

APPLICATIONS



TOP CAP



INNER MESH

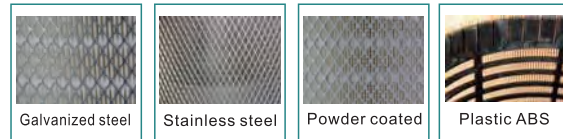

FILTER MEDIA

Cellulose polyester blend
100% cellulose
100% polyester

TREATMENT

Nano
Conductive
Flame Retardant
ePTFE Membrane
PTFE coating
Oil, water proof

BOTTOM CAP



OUTSIDE MESH/STRAPS

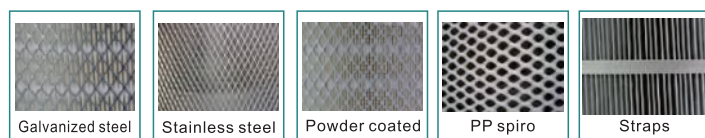

QFFC series

Quick fix top flange filter cartridges

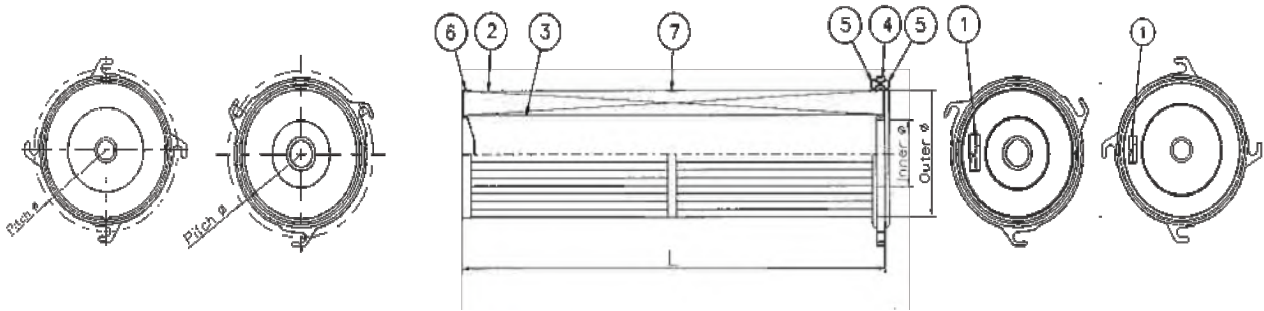

SPECIFICATIONS	
NO.	Description
1	Marking
2	Media pack
3	Inner liner
4	Top end cap - quick fix
5	Gasket (top and bottom)
6	Bottom end cap closed
7	Outer strap

TOP CAP



INNER MESH

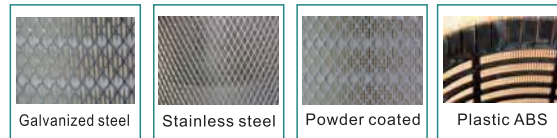

DIMENSIONS				
Model	OD (mm)	H (mm)	ID (mm)	Pitch (mm)
TN10551110F3	142	300	80	180
TN10552310F3	142	600	80	180
TN10553910F3	142	1000	80	180
TN10554710F3	142	1200	80	180
TN10612310F3	156	600	85	207
TN10613910F3	156	1000	85	207
TN10614710F3	156	1200	85	207
TN10852310F4	218	600	144	267
TN10853910F4	218	1000	144	267
TN10854710F4	218	1200	144	267
TN10852310F3	218	600	142	267
TN10853910F3	218	1000	142	267
TN10854710F3	218	1200	142	267
TN11272310F3	324	600	213	397
TN11272510F3	324	660	213	397
TN11273910F3	324	1000	213	397
TN11274710F3	324	1200	213	397



FILTER MEDIA

Cellulose + polyester
100% cellulose
100% polyester

TREATMENT

Nano
Conductive
Flame Retardant
ePTFE Membrane
PTFE coating
Oil, water proof

BOTTOM CAP



OUTSIDE MESH/STRAPS

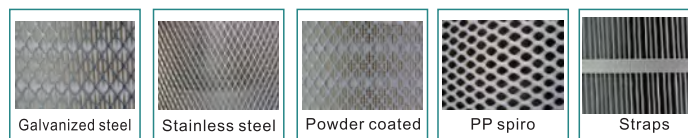

APPLICATIONS



SQFC series

Square Top flange filter cartridges

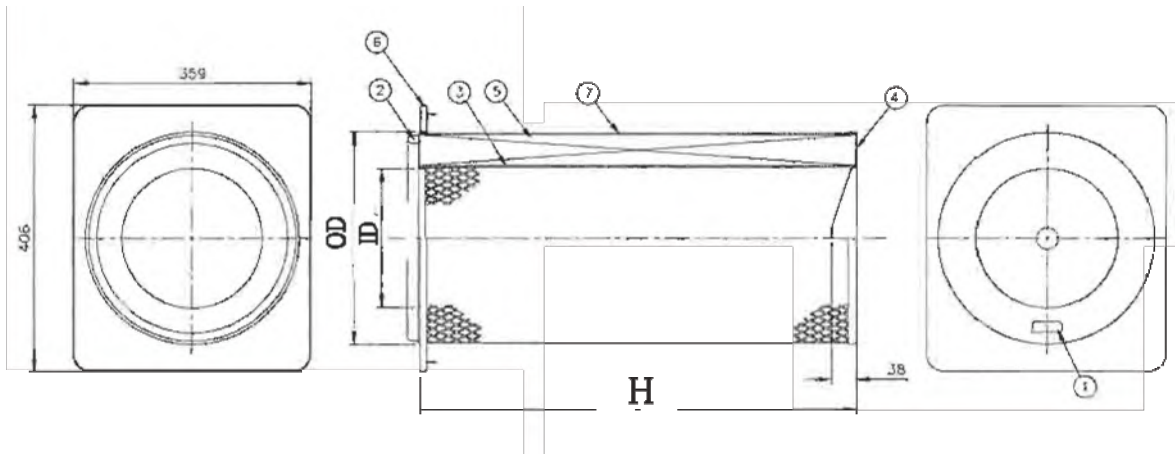

SPECIFICATIONS	
NO.	Description
1	Marking
2	Gasket
3	Inner liner
4	Bottom end cap without hole
5	Media pack
6	Top end cap (square)
7	Outer liner

DIMENSIONS					
Model	OD (mm)	H (mm)	ID (mm)	A (mm)	B (mm)
TN11272616	324	660	213	359	406
TN11273416	324	864	213	359	406
TN11272216	324	559	213	359	406
TN11273211	324	813	213	359	406
TN11273411	324	864	213	359	406
TN11273615	324	914	213	359	406
TN11513912	384	991	269	429	533

ADVANTAGES

- THENOW Pleat Separator Technology
- Low Pressure drop
- Extended Filter Life
- High Filtration Efficiency
- Pour in place one piece double geaket
- Broud design portfolio

END CAP



Galvanized steel



Stainless steel



FILTER MEDIA

Cellulose polyester blend
100% cellulose
100% polyester



TREATMENT

Nano
Conductive
Flame Retardant
ePTFE Membrane
PTFE coating
Oil, water proof

MESH



Galvanized steel



Stainless steel



Straps

FLC series

Flat cell air filter cartridge

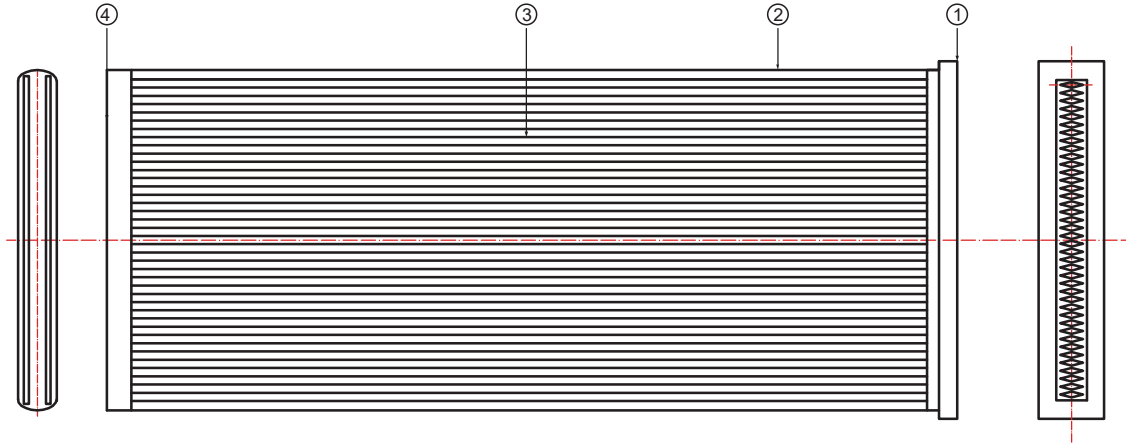

SPECIFICATIONS

NO.	Description
1	Open top end cap
2	Frame
3	Media pack
4	Open bottom end cap

ADVANTAGES

- Advanced media with ePTFE membrane
- Longer filter life and better pulse cleaning due to surface loading technology
- Exceptional dust cake release
- Lower energy use, reduced constant pressure drop
- High particulate capture rate
- Optimized filter performance

DIMENSIONS

Model	Width(mm)	Length(mm)	Filter Area (ř)
TN2192302	500	605	2.1
TN2214003	557	1040	4.4
TN2224202	575	1067	4.4
TN2193903	500	1000	4.0
TN2093203	250	820	3.9
TN2183703	465	950	2.8
TN2185902	480	1500	5.0
TN2244704	630	1200	5.5

APPLICATIONS



FILTER MEDIA
Cellulose polyester blend
100% polyester

TREATMENT
Nano
Conductive
Flame Retardant
ePTFE Membrane
PTFE coating
Oil, water proof

PLFC series

Pleated bag air filter cartridge

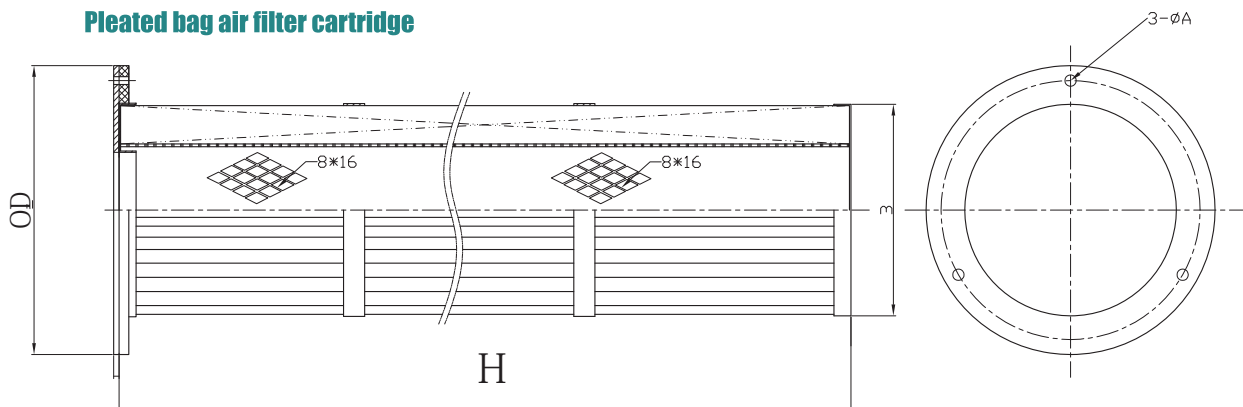

ADVANTAGES

- Advanced media captures submicron particles with proprietary nanofiber technology
- Lower pressure drop saves energy
- Longer filter life reduces maintenance costs
- Less production downtime
- Tough spunbond polyester substrate
- Provides high durability

Inner mesh



Galvanized steel



Stainless steel



Plastic ABS

DIMENSIONS

Model	Top or Bottom Load	OD(mm)	H(mm)	filter Area(m ²)
TN10442110	Top	112	533	0.7
TN10444010	Top	112	1034	1.44
TN10446110	Top	112	1557	2.2
TN10448010	Top	112	2032	2.88
TN10482110	Bottom	123	551	0.8
TN10484110	Bottom	123	1052	1.63
TN10486210	Bottom	123	1575	2.43
TN10488010	Bottom	123	2052	3.25
TN10532110	Top	135	533	1.1
TN10534010	Top	135	1034	2.2
TN10536110	Top	135	1557	3.3
TN10538010	Top	135	2032	4.4
TN10562110	Top	144	533	1.35
TN10564010	Top	144	1034	2.7
TN10566110	Top	144	1557	4.18
TN10568010	Top	144	2032	5.4
TN10582110	Bottom	147	549	1.35
TN10584110	Bottom	147	1049	2.7
TN10586110	Bottom	147	1572	4.12
TN10588010	Bottom	147	2050	5.4
TN10582510	Bottom	147	635	1.14
TN10584410	Bottom	147	1135	2.29
TN10586510	Bottom	147	1659	3.48
TN10588410	Bottom	147	2136	4.57
TN10592110	Bottom	151	549	1.14
TN10594110	Bottom	151	1049	2.29
TN10596110	Bottom	151	1572	3.48
TN10598010	Bottom	151	2050	4.57
TN10873910	Top	225	991	3.9



FILTER MEDIA

Cellulose polyester blend
100% polyester

TREATMENT

Nano
Conductive
Flame Retardant
ePTFE Membrane
PTFE coating
Oil, water proof

OTHER END CAPS



APPLICATIONS



COCY series

Conical/Cylindrical filter cartridges

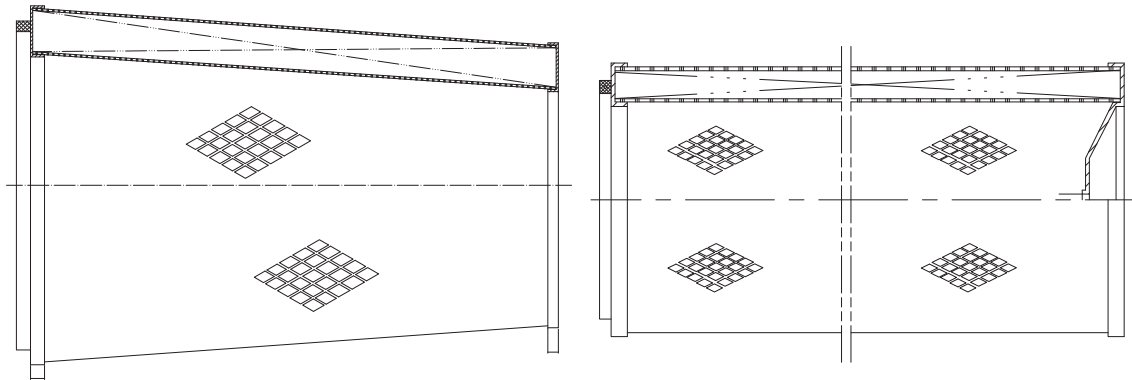

DIMENSIONS					
Model	Top cap OD (mm)	Bottom cap OD (mm)	Hole (mm)	Hight (mm)	Filter area (m2)
TN11602601(CO)	406	324	/	660	23
TN11272600(CY)	324	324	14/25	660	21
TN11752601(CO)	445	324	/	660	25
TN11272600(CY)	324	324	14/25	660	21

FILTER MEDIA

- Cellulose+synthetic / F9
- 100% synthetic / F9
- Cellulose+synthetic+nano /F9
- Cellulose+synthetic+nano+FR /F9
- 100% synthetic + ePTFE membrane / H10

TOP CAP



Galvanized steel Stainless steel Powder coated Plastic ABS

OUTSIDE MESH/STRAPS

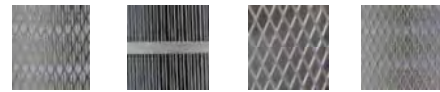

Galvanized steel Straps Stainless steel Powder coated

INNER MESH

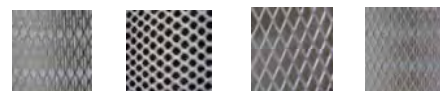

Galvanized steel PP spiro Stainless steel Powder coated

BOTTOM CAP

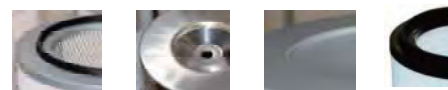

Galvanized steel Stainless steel Powder coated Plastic ABS



CYCY series

Cylindrical /Cylindrical filter cartridges

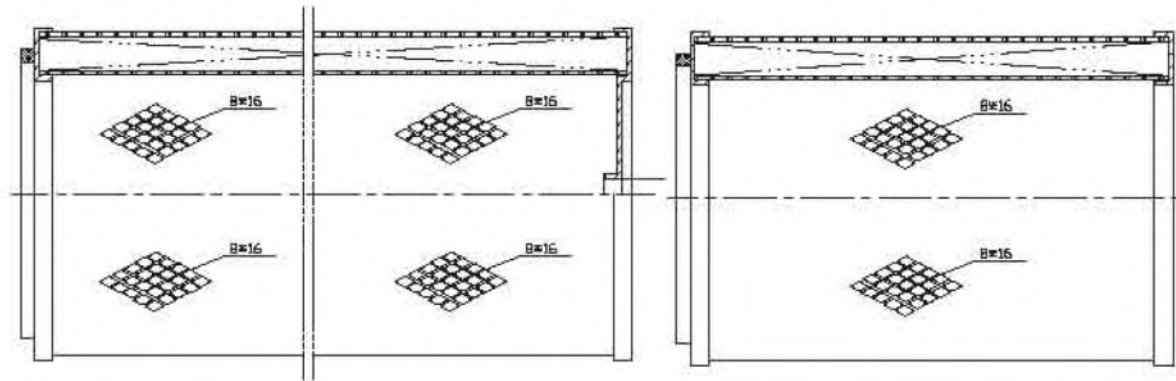

DIMENTIONS					
Model	OD (mm)	ID (mm)	Hole (mm)	Hight (mm)	Filter area (m2)
TN11272600	324	213	14/25	660	21
TN11272900	324	213	14/25	750	24
TN11273500	324	213	14/25	900	31
TN11273900	324	213	14/25	1000	31

FILTER MEDIA

- Cellulose+synthetic / F9
- 100% synthetic / F9
- Cellulose+synthetic+nano /F9
- Cellulose+synthetic+nano+FR /F9
- 100% synthetic + ePTFE membrane / H10



TOP CAP



Galvanized steel Stainless steel Powder coated Plastic ABS

OUTSIDE MESH/STRAPS

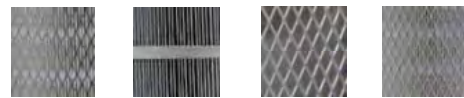

Galvanized steel Straps Stainless steel Powder coated

INNER MESH



Galvanized steel PP spiro Stainless steel Powder coated

BOTTOM CAP

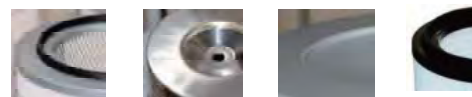

Galvanized steel Stainless steel Powder coated Plastic ABS

TLFC series

Twist lock filter cartridges

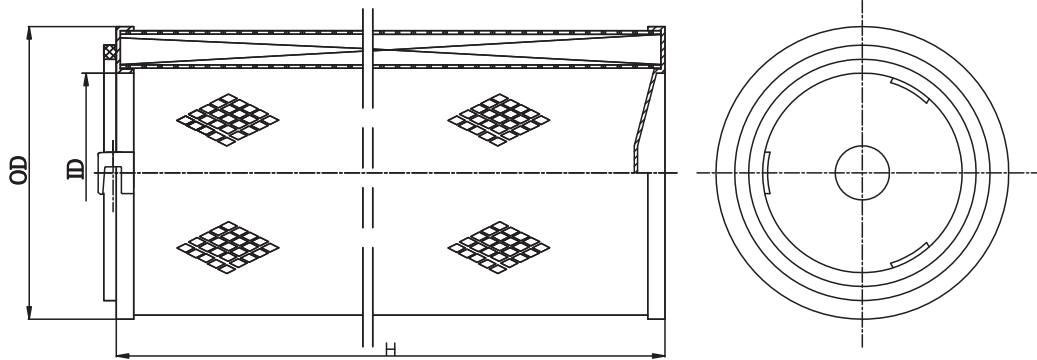

DIMENSIONS			
Model	OD (mm)	H (mm)	ID(mm)
TN11273431	324	864	213
TN11031831	264	457	154
TN11033631	264	914	154
TN11032231	264	559	154
TN11272631	324	660	213
TN11272731	324	711	213

FILTER MEDIA

- Cellulose+synthetic / F9
- 100% synthetic / F9
- Cellulose+synthetic+nano /F9
- Cellulose+synthetic+nano+FR /F9
- 100% synthetic + ePTFE membrane / H10

TOP CAP



Aluminium



Galvanized steel

GASKET



EPDM



Silicone



OUTSIDE MESH/STRAPS



Galvanized steel



Stainless steel



Powder coated

INNER MESH



Galvanized steel



Stainless steel



Powder coated

BOTTOM CAP



Galvanized steel



Stainless steel



Powder coated

SQFC series

Square Top flange filter cartridges

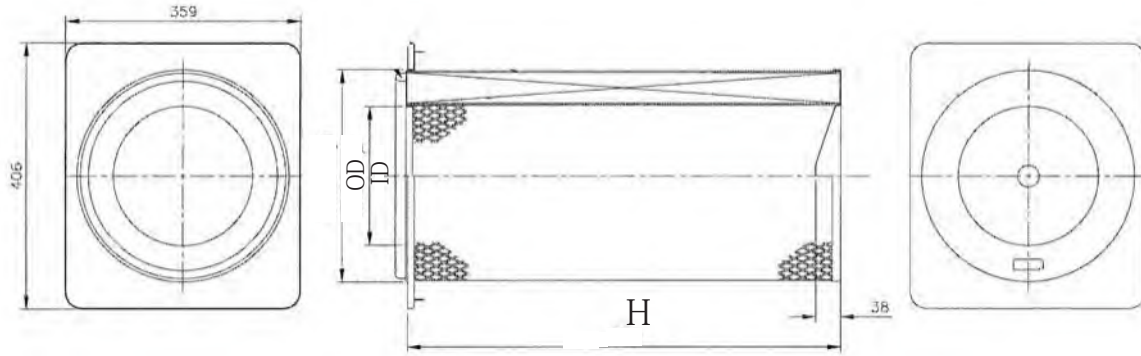

DIMENSIONS					
Model	OD (mm)	H (mm)	ID (mm)	A (mm)	B (mm)
TN11272616	324	660	213	359	406
TN11273416	324	864	213	359	406
TN11272216	324	559	213	359	406
TN11273211	324	813	213	359	406
TN11273411	324	864	213	359	406
TN11273615	324	914	213	359	406
TN11513912	384	991	269	425	533

FILTER MEDIA

- Cellulose+synthetic / F9
- 100% synthetic / F9
- Cellulose+synthetic+nano /F9
- Cellulose+synthetic+nano+FR /F9
- 100% synthetic + ePTFE membrane / H10

TOP CAP

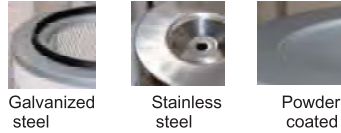

Galvanized steel Stainless steel Powder coated

OUTSIDE MESH/STRAPS



Galvanized steel Straps Stainless steel Powder coated

INNER MESH

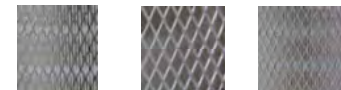

Galvanized steel Stainless steel Powder coated

BOTTOM CAP



Galvanized steel Stainless steel Powder coated



POGT series

Pocket filters for Gas Turbine Air Inlet System

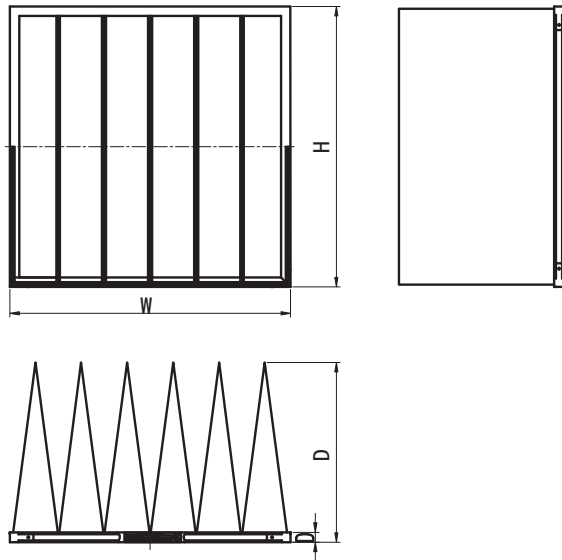

DIMENSIONS

Model	Width (mm)	Height (mm)	Depth (mm)	Filter Class	Media area (m ²)
TN22323251	592	592	640	M6	7.5
TN22323252	592	592	640	F7	7.5
TN22323253	592	592	640	F9	7.5
TN22323220	592	592	580	G4	4.1
TN22323070	592	592	195	G4	1.8
TN22323200	592	592	520	G4	3.7

ADVANTAGES

- Non discharging synthetic media
- Maximum surface use
- High mechanical strength
- Incinerable bags
- High dust holding capacity
- Long life
- Recommended choice for pre-filtration

TECHNICAL DATA

- Application: Installations exposed to turbulence and/or recurrent high humidity.
- Frame: Galvanized steel.
- Media: Synthetic fiber.
- Gasket: Neoprene.
- Recommended final pressure drop: 450 Pa / 1.8"wg.
- Temperature: 70°C / 158°F max. operating temperature.

PRGT series

Prefilter for Gas Turbine Air Inlet System

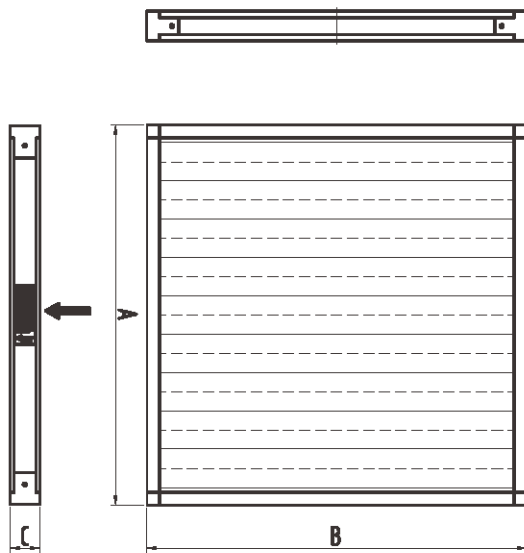

DIMENSIONS

Model	Width (mm)	Hight (mm)	Depth (mm)	Shape	Frame
TN22424041	610	610	102	Square	Beverageboard
TN22424030	610	610	89	Square	Beverageboard
TN22424042	610	610	102	Square	Metal
TN22424043	610	610	102	Square	Metal
TN22424040	444	610	102	Rectangle	Beverageboard
TN22424040	738	610	102	Rectangle	Metal

ADVANTAGES

- High mechanical strength
- Rigid, water resistant
- Cardboard frame
- Large media surface
- Unique radiel pleet design
- Bonded into case to eliminete
- Air bypass
- Compect

TECHNICAL DATA

- Application: Suitable for most areas
- Frame: Rigid water resistant beverage board/Aluminum
- Media: Blended cotton and polyester
- Others: Different clips available for mounting combination
- EN799:2012 efficiency: G4
- ASHRAE 52.2.2007 filter class: MERV 8
- Recommended final pressure drop: 250 Pa / 1.0 in.w.g
- Temperature: 70°C / 158°F max. operating temperature

VBGT series

V-Bank filters for Gas Turbine Air Inlet System

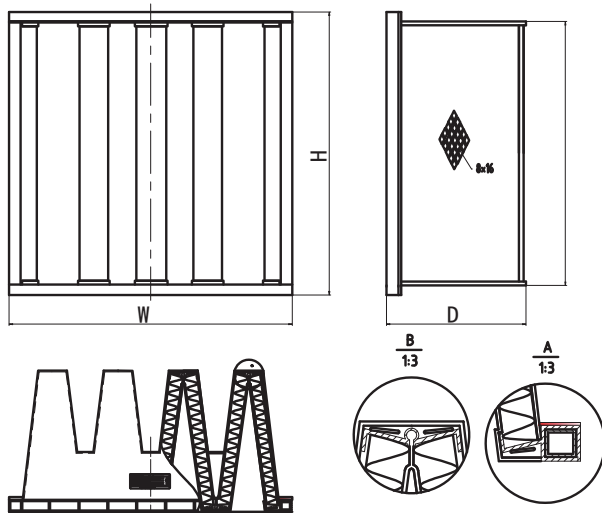

DIMENSIONS

Model	Width (mm)	Height (mm)	Depth (mm)	Filter Class	Media area (m ²)
TN22323111	592	592	292	F7	19
TN22323112	592	592	292	F8	19
TN22323113	592	592	292	F9	19
TN22323114	592	592	292	E10	19
TN22323121	592	592	315	F7	19
TN22323122	592	592	315	F8	19
TN22323123	592	592	315	F9	19
TN22323124	592	592	315	E10	19

ADVANTAGES

- Low pressure drop
- Large filter area
- Easy mounting
- 100% incinerable
- Heavy duty construction
- Aerodynamic construction

TECHNICAL DATA

Application: For dry areas, where high humidity and hygroscopic dust are less occurring.
 Type: Compact pleated filter.
 Frame: Injection moulded plastic part.
 Media: Glass fiber
 EN779:2012 efficiency: F7, F8, F9
 EN1822:2009 efficiency: E10
 ASHRAE 52.2.2007 filter class: MERV 13, 14, 15, 16
 Recommended final pressure drop: 600 Pa / 2.4"wg
 Temperature: 70°C / 158°F max. operating temperature

Principles of Filtration

Mechanisms There are five mechanisms by which particles are filtered from the air by air filter media. They include Straining (Sieving), Interception, Diffusion and Inertial separation and Electrostatic attraction. Each mechanism has a certain size range where it is the dominant factor for filtration of particles. Inertial separation and interception are the dominant collection mechanisms for particles greater than $0.2 \mu\text{m}$, and diffusion is dominant for particles less than $0.2 \mu\text{m}$. Electrostatic attraction is obtained by charging the media as a part of the manufacturing process.

Straining Straining occurs when the opening between the media members (fibers, screen mesh, corrugated metal, etc.) is smaller than the particle diameter of the particle the filter is designed to capture. This principle spans across most filter designs, and is entirely related to the size of the particle, media spacing, and media density.



Interception In order to be intercepted, a particle must come within a distance from a fibre of one radius of itself. The particle thus makes contact with the fibre and becomes attached. The interception mechanism can be contrasted with the impaction mechanism in that a particle which is intercepted is smaller and its inertia is not strong enough to cause the particle to continue in a straight line. It therefore follows the air

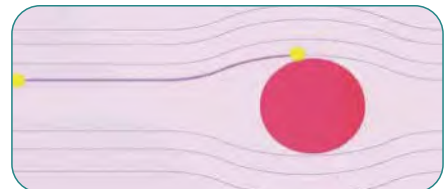

Diffusion Diffusion occurs when the random (Brownian) motion of a particle causes that particle to contact a fiber. As a particle vacates an area within the media, by attraction and capture, it creates an area of lower concentration within the media to which another particle diffuses, only to be captured itself. To enhance the possibility of this attraction, filters employing this principle operate at low media velocities and/or high concentrations of micro fine fibers, glass or otherwise. The more time a particle has in the "capture zone", the greater the surface area of the collection media (fibers), the greater the chances of capture. Filter manufacturers have two distinct methods of addressing this principle — employ more square footage of fine glass-mat type media or employ less



Inertial Separation Inertial Separation uses a rapid change in air direction and the principles of inertia to separate mass (particulate) from the air stream. Particles at a certain velocity tend to remain at that velocity and travel in a continuous direction. This principle is normally applied when there is a high concentration of coarse particulate, and in many cases as prefiltration mode to higher efficiency final filters.

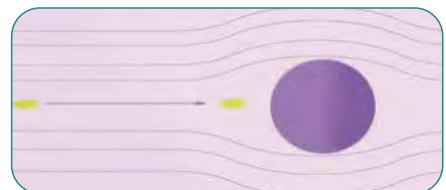

Electrostatic Attraction Filters utilizing large diameter fibre media rely on electrostatic charges to increase their efficiency of fine particle removal. Large diameter fibre media is normally chosen due to low cost and air flow resistance. However, these filters often lose their electrostatic charge over time because the particles captured on their surface occupy charged sites, thereby neutralizing their electrostatic charge.

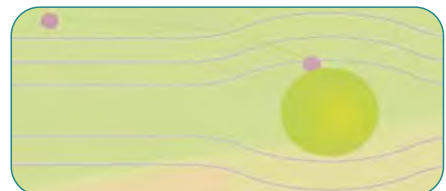

Applications



Related workmanship: Welding, grinding, sandblasting, abrasive blasting, plasma, laser cutting, spraying and so on. Dust characteristics varies among these workmanship. We can supply all kinds of filter medias and filter elements according to your specific operating environment.



Dust characteristics: Plenty of small particles, high permeability and temperature; and these working environments need high dust filtration efficiency and load capacity. **Mainly related workmanship:** Grinding, flame spraying, welding, galvanization, and casting.



Related workmanship: Sawing, cutting, grinding and so on. **Dust characteristics:** Particles diameter range from 3 micron to 20 microns. Easy explosive and flammable.



Related workmanship: Blasting, mechanical cutting, cutting, friction, vibration and so on. **Dust characteristics:** There are rock dust, mine dust and so on, which is extensively concentrated, explosive and hazardous.



Dust characteristics: Mainly are fiber, which need specific filter media, such as high liquidity, good cleaning performance and big filter area. Easy to generate static electricity.



Dust characteristics: Highly corrosive, especially alkaline or acidic dust and others with complex chemical composition. These industry has stringent emission standards.



Dust characteristics: Dust generated by this industry is very hard and rough. Long pleated filter cartridge is a better option compared with filter bag in terms of both cost and efficiency.



Environments requirement: Highly clean room. When considering the standard, the filtration products must meet the required certificates, such as FDA.



Dust may generate in the major cigarette factory and redrying tobacco factory production workshop, tobacco volume wiring, etc. We recommend using tobacco specialty cartridge, which using composite fiber filter material, resistant to tar and its main feature is pleated wide apart, handling large air volume and so on.



Main gas turbine brands: GE, SOLAR, SIEMENS, Alstom, MITSUBISHI. Except for the normal filter cartridges, we can also offer special one whose efficiency can reach 99.99% @ 0.5 micron. Also we can provide three-grade-filtration, rain gate or filter cotton as first grader, two and three grade use HEPA filter.

We offer a wide range of filter media and filter cartridges enabling us to meet the demands of almost any industry.

If you have specific request, feel free to contact us, and our R&D team can help you to find a solution. According to your special operating environment, we have following options to meet your standard:

- Filter cartridges
- Pleated bag filters
- Panel filters
- Pocket filter

Filter Media: Polyester, Cellulose, Synthetic

Post-processing: Nano flame retardant; Nano; Anti-static; Flame retardant; oil, waterproof; PTFE membrane; PTFE membrane FR; Anti-static PTFE membrane

»»» Thenow

Thenow was established in 2005, belonging to Apureda Group as the wholly-owned subsidiary. Being a standard maker, Apureda Group is a global specialist in the development and production of filtering systems and solutions with 6 production units.

As one of Apureda Group's production units, Thenow's business is to provide customers with sustainable best in class air filtration products and services. We mainly focus on manufacturing industrial filters including dust collector filters, gas turbine intake air filters, HVAC panel filters, oil mist collectors and air purifying filters.



Our business concept is to optimize our product quality and service to be in line with customers' needs. Compared with standard filters, Thenow's products can reduce the operating costs of filtration systems, by keeping their pressure drop low over a longer time. Our filters can catch more contaminants and operate at lower average resistances because of better designed filter media and larger filter media surface. Thenow's products are widely used in various fields such as petroleum, chemical industry, steel, paint, electronics industry, pharmaceutical industry, shipping, cement, gas turbine, HVAC etc.

We are reliable because we know the market and we are honest and truthful. Our people, products and processes must always meet, or even supersede the agreed results.

»»» Production

Thenow filters are manufactured on 3 advanced, all-process production lines which are under strict quality guidelines and equipped with electronically controlled state-of-the-art production machines such as CNC punch press, CNC lathes, CNC wire cut machine, CNC bending machines, electronic pleating machine, etc. Besides, manual production is also an important component of Thenow's business philosophy. We can guarantee a high quality product at the end of our production process with our highly qualified staff, a globally standardised management system and our close attention to rigorous guidelines.



»»» Quality Control



Except for our internal strict quality control system, our plants also strictly adhere to the standards of ISO 9001 system. And our products meet the compliance of EU directives and regulations.

Since our inception, quality has been the sole guiding force. We have a separate department for maintaining the quality of our products. They have a unique documentation system & material traceability systems for quality control of products. Products are consigned to the department for inspection before their market release. Besides, quality inspection is also an integral part of the manufacturing process, originating with research and development and carrying through with manufacturing best practices.



In today's global economy, however, meeting or exceeding OEM standards for fit, form and function are no longer enough. We must also traverse the globe in search of the most competitive costs possible, while never compromising on quality.

»» R&D



Thenow is a manufacturer with a huge interest and stake in technology. We have always made substantial investments in R&D for about 3-5% of annual turnover in order to meet the high demands of our customers because it is a very important factor for the future of Thenow and the filtration industry.

Besides, Thenow also has a wide range of test equipment for On-Site measurements including particle counters, pressure gauges, airflow meters and gas analysis equipment.

Using advanced research and test equipment in our laboratories, some of which are unique and feature proprietary designs, we can conduct R&D to meet the growing need for air filtration solutions that safeguard health, satisfy stricter energy efficiency and sustainability standards, and meet emerging needs for high-tech filtration. We can also steadily maintain, improve and advance our product and drive the development of new innovative filters and solutions.



»»» Service

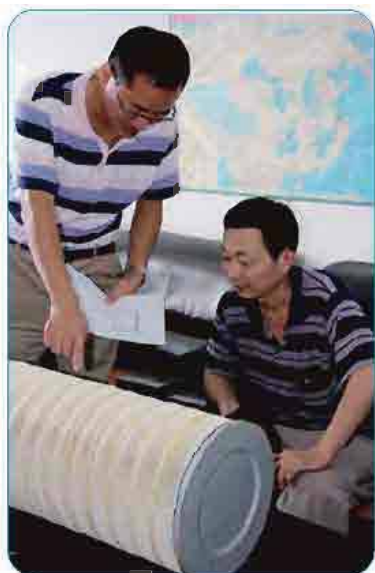

Thenow's qualified staffs are glad to support the customers in all matters concerning the efficiency and operations of our products. We provide our customers in very diverse sectors of industry with maximum benefit from our top-quality filters installed in their highly-complex plant. The flexible and customized package comprises a comprehensive filter program plus service support plus warranties - all at guaranteed fixed costs to bring our partners system solutions that are innovative, high-performance, economically efficient, environmentally friendly and offer excellent value for money.

- Technical service support and maintenance of mechanical and electrical system components
- Filter acceptance measurements
- Measuring dust emissions and immissions
- Technical acceptance testing of the filter and ventilation systems
- Checking the systems' technical condition, weak-point analysis
- Documentation of all work performed





SHANGHAI THENOW PURIFICATION TECHNOLOGY CO.,LTD.
Add:No.59 Linsheng Road,Tinglin Town,Jinshan District,Shanghai,China

Tel: +86 21 59177719

Fax: +86 21 66613500

E-mail: info@thenow.cn

Website: www.thenowfilter.com

